

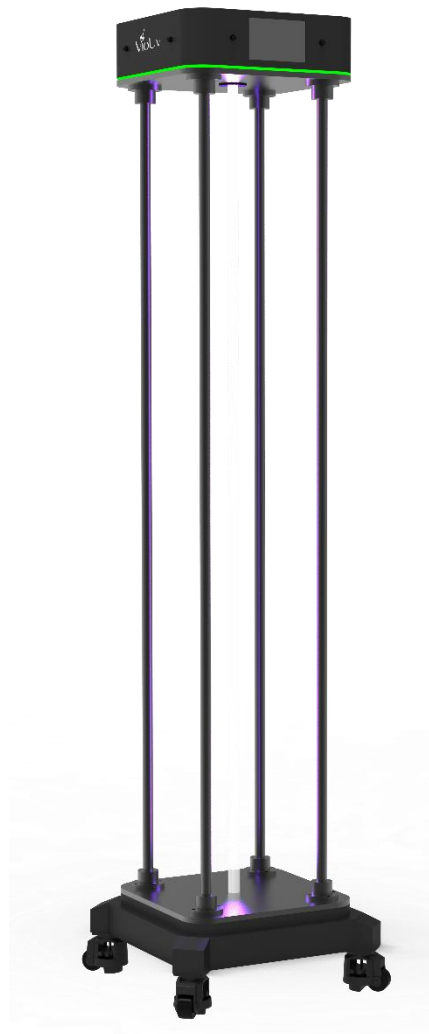

Operating Instructions

UVC Germicidal Lamp

Model No.: VIO325



Please read these instructions completely before operating this Unit



GENERAL PRODUCT DESCRIPTION AND WARNINGS

VioUV delivers ultraviolet energy at a wavelength of 254 nanometers. This is a highly effective wavelength against bacteria, mold spores, microbes, viruses, and superbugs. Germicidal ultraviolet rays are harmful to eyes, skin, pets, plants. Safety procedures **MUST** be implemented to prevent exposure.

VioUV should be used as a supplement to your facility's disinfection cleaning sanitization protocols and not as a substitute to basic procedures. All cabinets and drawers should be open for treatment to allow as much penetration of the UV light possible and have optimum sterilization. Shadows will not be sterilized. Implement and follow a disinfectant protocol. VioUv does not leave any residual substance or harmful by products.

No warranty or representations are made by VioUv. Each individual facility is responsible in validating the suitability and protocols for their use.

Indoor Use Only: VioUv must be indoors protected in a location that between 40 to 95 degrees Fahrenheit.

The UV treatment results achieved are subject to variations in application conditions, it is recommended that culture tests be performed to confirm desired outcomes.

Safety procedures **MUST** be implemented to prevent ultraviolet exposure of people, pets, & plants.

Buyer will inspect product after receipt. In the event the product has an issue and claim is not made within 7 days of receipt buyer forfeits and waives the right of warranty.



VioUv under no circumstances will be liable for any incidental, consequential or specific damage, loss or expenses arising from the contract for this product, or in connection with the use of, or inability to use, our product for any purposes whatsoever.

CAUTION: Wear protective gloves when handling broken ultraviolet lamps. Do Not use a vacuum cleaner to pick up glass. Sweep glass up into a plastic bag or box and dispose in accordance to local and/or state laws.

SAFETY WARNINGS/ INSTRUCTIONS:

All personal should be trained and alerted of potential hazards. All people, pets, and plants need to leave treatment area. NO ONE can be in treatment area will light is on.

Indoor use only

Do not alter design or construction

Do not use VioUV for any other purpose than it's intended use as described in the manual

During treatment DO NOT ENTER sign must be displayed

Do not operate if power-cord or plug are damaged.

Do not remove any labels

CAUTION: Ultraviolet Lights can and may break down change color crack and fade plastic, rubber, art, canvases, material, or other nonmetallic materials with inadequate resistance to Ultraviolet Light.



CONTENT

| | |
|---|-----|
| 1. Safety Instructions and Precautions..... | 3 |
| 2. Product Introduction | 4 |
| 2.1 Brief Introduction..... | 4 |
| 2.2 Outline of the Product | 5 |
| 2.3 Specifications | 6 |
| 3. Installation Instructions | 7 |
| 4. Operating Instructions | 10 |
| 4.1 Preparatory Work | 10 |
| 4.2 Start the Machine..... | 11 |
| 4.3 Calibration Time..... | 11 |
| 4.4 Three Working Mode to Choose from | 12 |
| 4.5 Sterilization Ended..... | 14 |
| 5. Maintenance and Troubleshooting | 14 |
| 5.1 Cleaning | 144 |
| 5.2 Trouble Shooting..... | 14 |
| 6. Limited Warranty | 145 |
| 7. Contact Information..... | 146 |

Safety Requirements and Notes



Please read this manual carefully prior to using the device!

- ◇ This instrument is strictly forbidden to be used in flammable, explosive and other dangerous environments.
- ◇ The instrument must be properly grounded before using.
- ◇ In order to extend the service life of the lamp and the instrument, please turn off the power at the unit when not in use.
- ◇ After the UV lamp is turned on, do not touch any part of the unit as the surface temperature of the UV output part will exceed **41° C or (106 Degrees Fahrenheit)**

1. Safety Instructions and Precautions

Safety precautions should be taken when using the UVC Germicidal Lamp. The products undergoes strict safety test before delivery, therefore standard operations will not lead to safety accidents. To protect the customers, operators, and other personnel, please read the following precautions carefully before operation.

- ◆ Failure to control, adjust or operate the machine in accordance with the requirements of this manual may cause safety accident. Therefore, users and technicians who operate or maintain the machine must be familiar with the safety requirements and operating procedures before turning it on.
- ◆ No one is allowed to overhaul the inner structure of the machine except for those technicians authorized by VioUV. Be careful of high voltages danger inside the machine.
- ◆ Make sure that the rated voltage of this machine matches the voltage of your country (AC100-240V / 50-60Hz)
- ◆ Disconnect the power supply before cleaning and maintenance, otherwise physical injury or equipment damage may be caused
- ◆ The machine should be placed on a flat ground and ensure that the working environment is clean and free of dust.
- ◆ The lamp will emit ultraviolet light. To avoid eye injury, do not look directly at the light tube. Necessary protective measures should be taken during use, like protective glasses
- ◆ It is strictly forbidden to expose skin to the lighted ultraviolet lamp for a long time to prevent skin damage, pigmentation, roughening and aging.

- ◆ If you touch the lamp with bare hands, it will get dirty and need to be cleaned with alcohol before use. Always use clean fabrics or clean gloves when you touch it.
- ◆ Mercury lamp tube contains mercury and there is a risk of mercury poisoning. Dispose of new, used, or damaged lamps in accordance with relevant laws or regulations and prevent skin contact with broken lamp parts.
- ◆ Ozone will be generated when the lamp is working. To avoid any possible harm from Ozone, make sure to ventilate the room for 30 minutes before entering the room.
- ◆ VioUV does not assume any responsibility for injury or damage caused by improper use.



SAFETY PRECAUTIONS

Avoid exposure to UV light. Germicidal ultraviolet rays are harmful to the eyes and skin. Check the room to clear it of people, animals, and plants before using.
Manage in accordance with your local disposal laws, see: www.lamprecycle.org

2. Product Introduction

This is a general description of UVC Germicidal Lamp.

2.1 Brief Introduction

The UVC Germicidal Lamp is efficient and convenient disinfection and sterilization equipment, which applies 254nm UVC band ultraviolet. The radiant energy is 100% concentrated at 254nm, which destroys the molecular structure of DNA (deoxyribonucleic acid) and RNA (ribonucleic acid) of microbial cells to achieve the effect of sterilization and disinfection.

The special amalgam technology can help it to maintain high output efficiency in the temperature range of 40-100 ° C; the coating of the protective layer on the inner wall of the lamp tube can ensure stable output during the entire service life.

2.2 Outline of the Product

The UVC Germicidal Lamp is mainly composed of the following parts: Upper and Lower Modules, Lamp Tube, Display, Supporting Pole, etc.

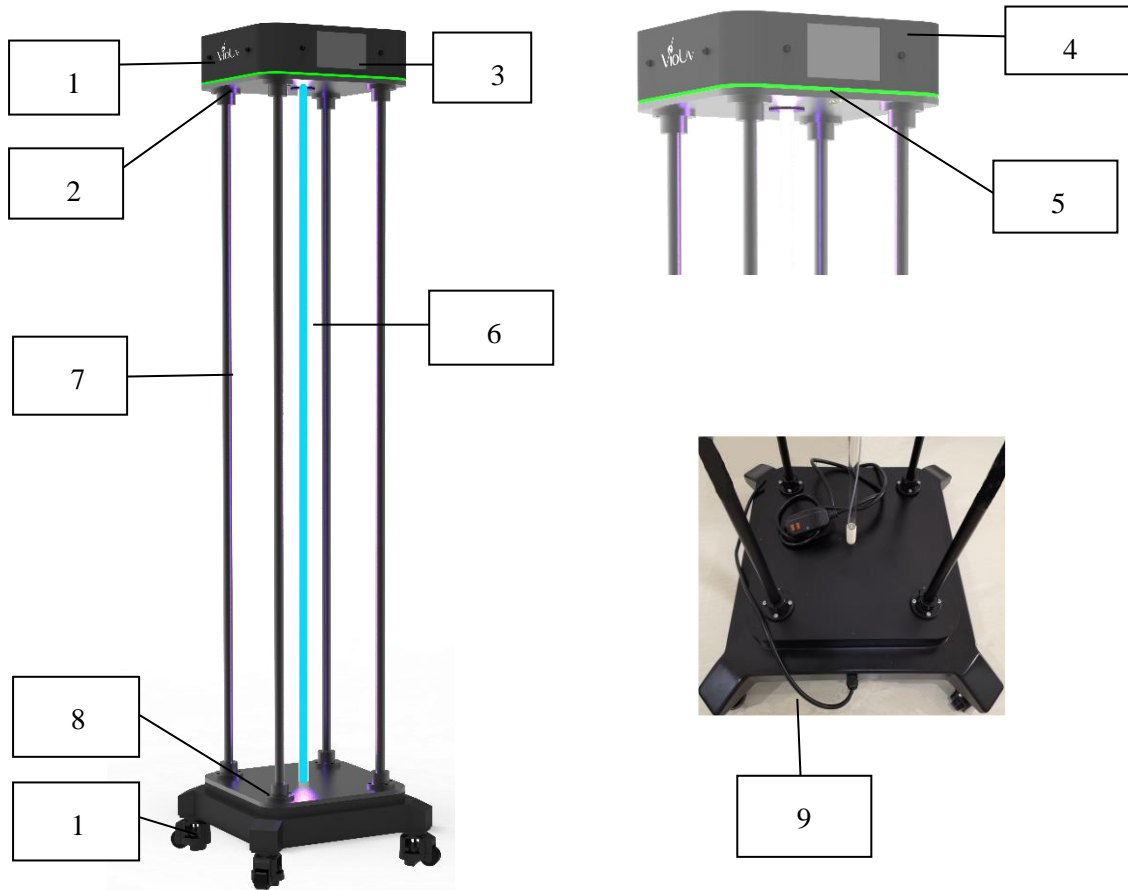

| Items | Description | Function |
|-------|-----------------|--|
| 1 | Upper Module | Consist of PCBA, display etc.. |
| 2 | Indicator Light | Indicate different status of the machine |
| 3 | Display | Present the interface |
| 4 | Motion Sensor | To detect human body |
| 5 | Power Button | To start the machine |
| 6 | Lamp Tube | To emit UV light |
| 7 | Supporting Pole | To support the Upper Module |
| 8 | Lower Module | Consist of power supply, ballast resistor ect. |
| 9 | Power Cord | To connect the power supply |
| 10 | Trundle | To make it easy to move |

2.3 Specifications

Please refer to the following table for more details.

| Item | Specifications |
|-------------------|--------------------|
| Part No. | VIO325 |
| Wavelength | 254nm |
| Power Supply | AC100-240V/50-60Hz |
| Input Power | 350W |
| Power of the lamp | 325W |
| Dimension | 442mm×442mm×1801mm |

Detailed Description of Product Use:

- Plug the unit into a 110 outlet.
- The lamp will have a warm-up period of 30 seconds. During the warm-up period, the two ends of the lamp will turn red until they are fully lit.
- Position the unit in the center of the room to be disinfected (optimal line of sight)
- Shield all items that could be adversely affected by the UV-C rays.
- Clear the room of humans and animals.
- Turn on the unit utilizing the remote control.
- Set the delay with audible countdown (the 360-degree motion sensor activates automatically)
- Set the exposure time
- Press start and immediately leave the room.
- Hang exposure UV warning sign on the exit door.
- Prior to re-entry make sure the lamp is OFF before entering
- Turn the system to off and unplug from wall.

3.Installation Instructions

Installation instructions are included in this chapter. The machine is disassembled into 4 parts before delivery, including the Upper Module, Lower Module, Lamp Tube and Supporting Pole. It can be easily reassembled by following the steps below.

Step1: Pass the low-voltage power supply line through a Support Pole; insert the Supporting Pole into the Fixed Base on the Lower Module; tighten the fixed base with an Allen Wrench Screws. Also insert the other three Supporting Poles into the Fixed Bases and tighten the screws.

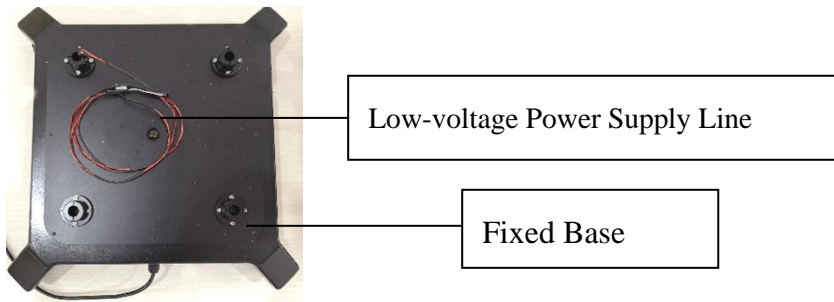

Fig.3.1



Fig.3.2

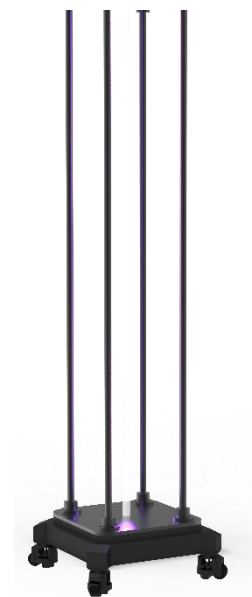

Fig.3.3

Step2: Put the Upper Module on the table as shown is Fig.3.4; fasten the 8 screws on the Upper Module with M4 Allen screwdriver. Lift the upper cover with both hands as shown in Fig.3.5, after the Low-voltage power supply line is through the fixed base, put the 4 Supporting Pole into the 4 fixed base, put the upper cover down. The Power Button should be on the opposite side of the Power Cord, please refer to Fig.3.6 below.

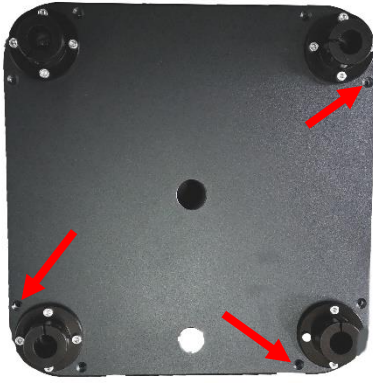

Fig.3.4

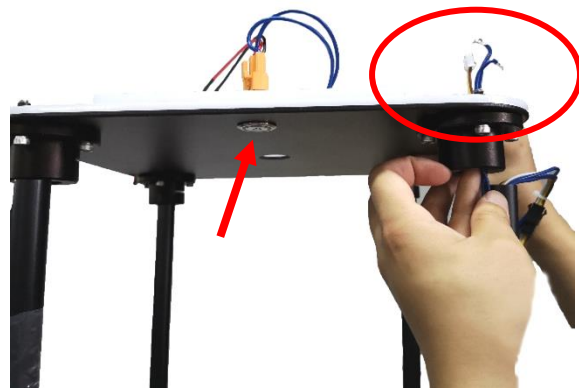

Fig. 3.5

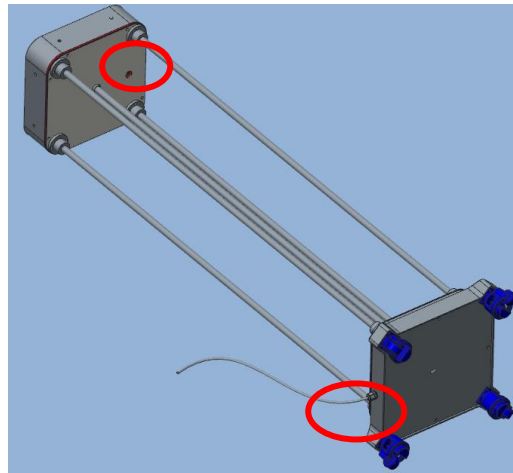

Fig.3.6

Step3: As shown in Fig.3.5, there are 2 stripped pins. Insert the pins to the end of the terminal as in Fig.3.7; pull the orange handles down as in Fig.3.8

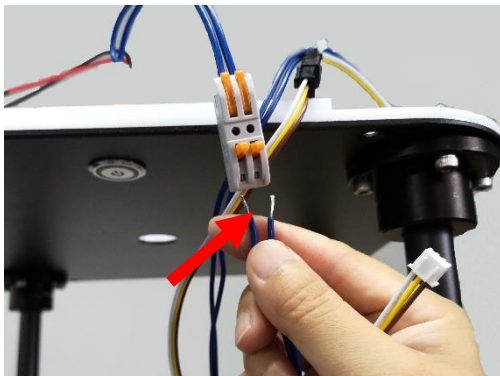

Fig.3.7

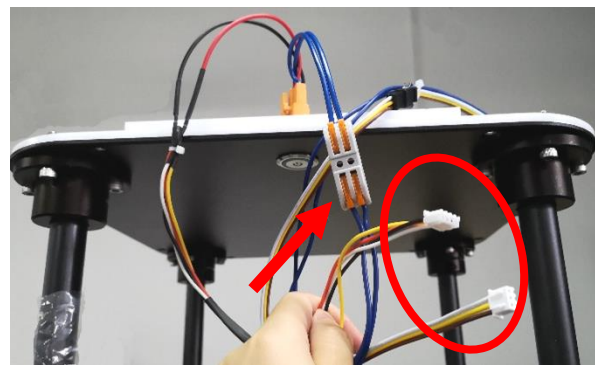

Fig.3.8

Step4: Get the Upper Module, adjust the position of the Upper Module to make the Power Button and Display on the same side. Connect the terminals as in Fig.3.7 with the 2 white terminal blocks on the PCB in Fig.3.10; put the Upper Module on the upper cover.

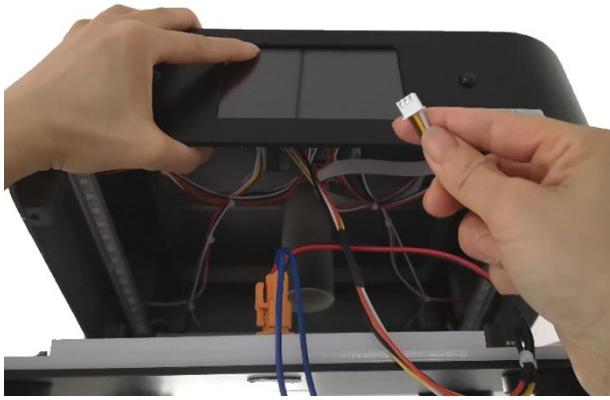

Fig.3.9

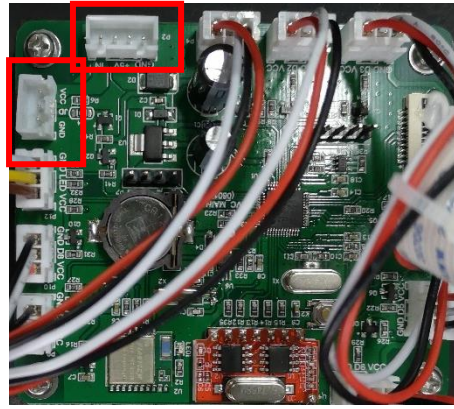

Fig.3.10

Step5: As shown in the Fig.3.13, hold the lamp with both hands, insert the top of the lamp (Fig.3.11) into the hole in the middle of the upper cover at a slight inclined angle; connect the pin at the end of the lamp (Fig.3.12) with the hole in the middle of the lower assembly docking Fig.3.14 .



Fig.3.11

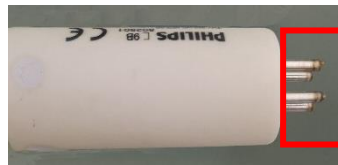

Fig.3.12



Fig.3.13

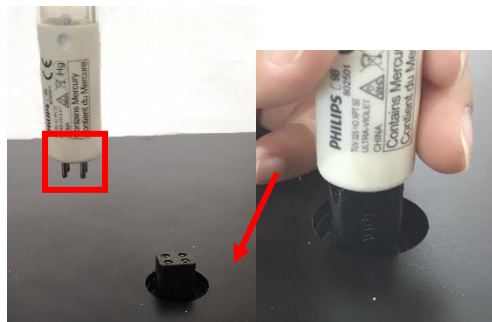

Fig.3.14

Step 6 : Put the silicon rubber accessory to center of the Upper Module(Fig.3.15);

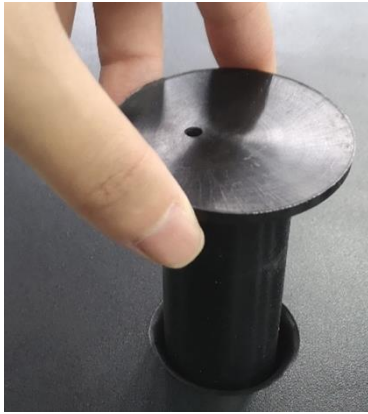

Fig.3.15



Fig.3.16

Step 7 : Tighten the Upper Module and upper cover with screws.



Fig.3.17

4. Operating Instructions

4.1 Preparatory Work

Pay attention to the ambient temperature, the ultraviolet radiation intensity and affect the sterilization effect would be affaced when it is too hot or too cold. The ultraviolet radiation intensity is maximum and stable when the room temperature is between 20 and 40°C. If the temperature is lower than 20 °C or higher than 40 °C, it is necessary to prolong the ultraviolet irradiation time accrodingly.

Pay attention to the environmental humidity. When the humidity is between 55% and 60%, ultraviolet rays have the highest rate of killing bacteria, however when it exceeds 60%, the penetration of ultraviolet rays will decrease, and the sterilization effect will decrease by 20% to 30%.

Finally, do not look directly at the luminous lamp with naked eyes or exposed your skin to the illuminated ultraviolet lamp for a long time. During disinfection, close the doors and windows. People and pets must leave the disinfection place, plants and valuable leather goods

and other items should also be moved to places that are not exposed to ultraviolet rays or cover them with cloth.

Note: We suggest holding the lamp tube with clean fabrics or gloves. If you touch the lamp with bare hands, the surface will get dirty, and need to be cleaned with alcohol before use. You can use remote control to operate the machine without protective glasses or clothing.

4.2 Start the Machine

Connect the machine with AC100-240V wall plug, press the Power Button (as shown in Fig.4.1), the Indicator Light becomes green; the display is on (as shown in Fig.4.2) and then enters to the main interface. The Indicator Light soon becomes red when human body is detected.

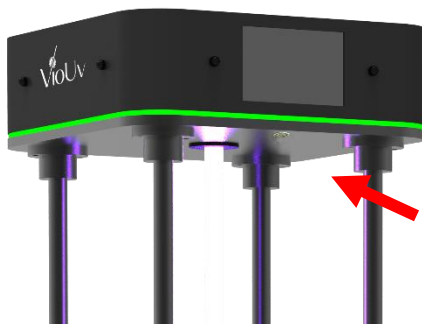

Fig. 4.1



Fig. 4.2

Note: Green light indicates the machine is well connected with the power supply; Blue light indicates the system is running and the lamp is lighting; Red light indicator human body detected by the motion sensor.

4.3 Calibration Time

The time calibration can be done by pressing the time displayed on the upper left corner of the main interface. Set second-minute-hour-date-month-year, press Confirm to finish, then it goes back to the main interface automatically.

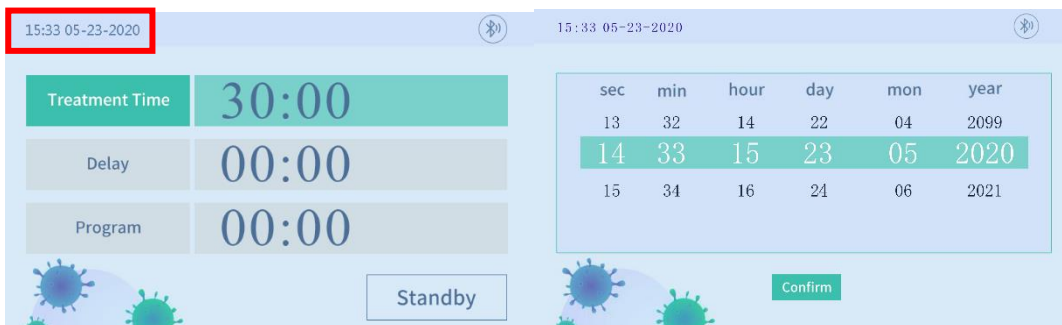

Fig.4.3

Fig.4.4

Note: Time Calibration is not needed for the initial starting of the machine.

4.4 Three Different Modes to Choose from

The machine is designed with three modes, from which you can choose the most suitable one upon various needs.

To set up Treatment Time

Under any of the three modes, you need to set up treatment time as described below.

Press the numbers on the right of Treatment Time Icon to set the sterilization time; slide up or down to choose the time needed ; and the numbers stands for minutes, press Confirm to finished your setup, then the system goes back to the main interface.



Fig 4.5

Fig 4.6

Treatment Time Mode

Under this mode, you can start the sterilization process immediately after setting up the treatment time.

After setting the duration, user walk away out the the sensing range, the Indicator light gets green; press ON button on the remote control, the Indicator light gets blue, the lamp starts lighting, and the color of the lamp gradually changes from pink to purple; when it begins to countdown, the system changed from Standby to Lighting. As shown in Fig4.8, the sterilization time is 30mins, and the duration can ring from 1 to 60 minutes.



Fig 4.7

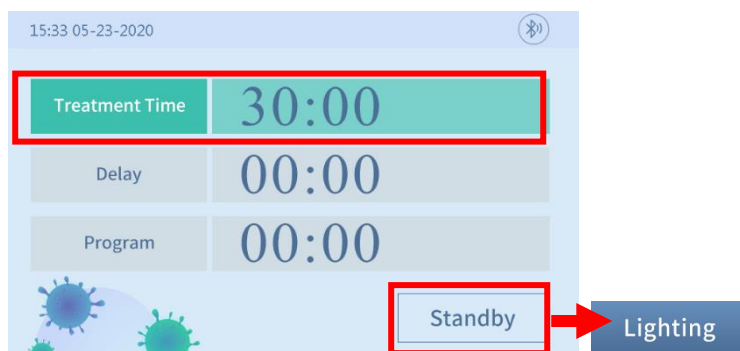

Fig 4.8

Delay Mode

Under this mode you can start sterilization after a few minutes.

Set up the treatment time, then press the Delay icon, the icon gets green; press the numbers on the right of the icon to set the delay time. This number indicates after a few minutes the machine the lamp begins lighting. Walk away out the the sensing range, the Indicator light gets green; press ON button on the remote control, the Indicator light gets blue, the systems change from Standby to Running. When finished countdown, the time get “00 : 00”, it in Lighting status. As shown below, it means that the machine begins sterilization after 1 minute and 30mins duration, which can ring from 1 to 60 minutes.

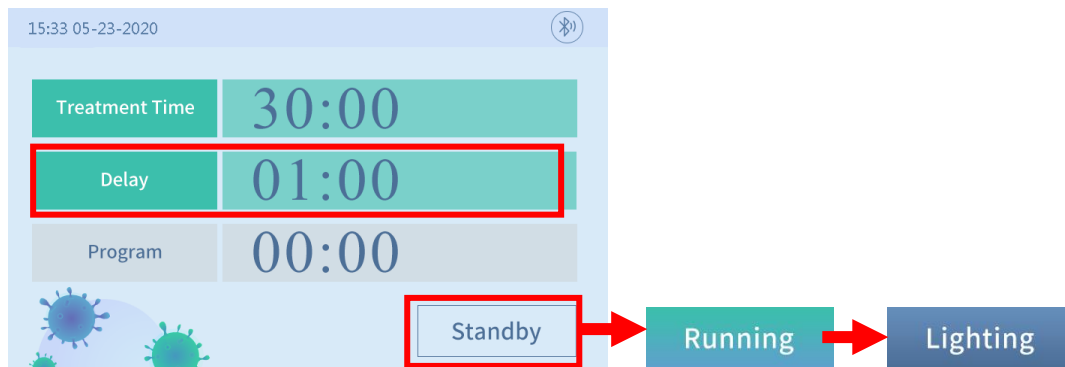

Fig 4.9

Program Mode

Under this mode you can set the exact time you would like it to start sterilization process. Set up the treatment time, then press the Program icon, the icon gets green; press the numbers on the right of the icon to set the time. This number indicates at the exact time, the lamp begins lighting. When user walk away out the the sensing range, the Indicator light gets green; press ON button on the remote control, the Indicator light gets blue, the systems changes from Standby to Running. When the exact time “08 : 00”, the lamp begins lighting at 8 am. It can be set from 00:00 to 23:59.



Fig 4.10

4.5 Sterilization Ended

The system stops lighting when the circle completed. If you need to stop sterilization in advance, just press the OFF button on the remote control. We suggest ventilating before entering the room, for Ozone may cause harm to human and animal health.

5. Maintenance and Troubleshooting

The following are suggestions for daily maintenance and solutions for common problems of the machine. And only the maintenance below is allowed, other maintenance behavior can only be conduct by authorized technicians by VioUV.

Note: Disconnect the power supply before maintenance

5.1 Cleaning

We suggest holding the lamp tube with clean fabrics or gloves. If you touch the lamp with bare hands, the surface will get dirty, and need to be cleaned with alcohol before use. Clean the surface of this product with a soft damp cotton ball at least once a week. You can use neutral detergent or pure water to wipe off the stains. Acidic or alkaline detergents are strictly prohibited.

5.2 Trouble Shooting

| Problem | Possible Cause | Solution |
|---|--|-------------------------------------|
| No display | Not well-connected with the power supply | Confirm if the power supply |
| | The Power Button is not pressed | Press the button the start the |
| No response when touch the interface | System Failure | Contact our after-sales department. |
| Cannot enter to the main interface | System Failure | Contact our after-sales department. |
| No response when press the On/Off Button of the remote controller | The remote control is not paired with the system | Contact our after-sales department. |

NINETY DAY LIMITED WARRANTY

Warranty Description:

From the date of installation of the instrument, VioUv provides a 90-day limited warranty. Within the warranty period we will repair or replace products that are returned to us with shipping charges prepaid and that have been determined by VioUv to have a manufacturer defect. This warranty does not apply to products that have been mistreated, subject to misuse, negligence, or accident. This warranty does not apply to products that have been modified, improperly installed, repaired by third party or unauthorized person. Warranty will not apply to products that do not have the original product safety labels.

TO THE EXTENT PERMITTED BY LAW, THE WARRANTY AND REMEDIES SET FORTH ABOVE ARE EXCLUSIVE AND IN LIEU OF ALL OTHER WARRANTIES AND REMEDIES, AND WE SPECIFICALLY DISCLAIM ALL STATUTORY OR IMPLIED WARRANTIES, INCLUDING, BUT NOT LIMITED TO, WARRANTIES OF MERCHANTABILITY, FITNESS FOR A PARTICULAR PURPOSE AND AGAINST HIDDEN OR LATENT DEFECTS. IF WE CANNOT LAWFULLY DISCLAIM STATUTORY OR IMPLIED WARRANTIES, THEN TO THE EXTENT PERMITTED BY LAW, ALL SUCH WARRANTIES SHALL BE LIMITED IN DURATION TO THE DURATION OF THIS EXPRESS LIMITED WARRANTY AND TO REPAIR OR REPLACEMENT SERVICE.

SOME JURISDICTIONS DO NOT ALLOW LIMITATIONS ON HOW LONG A STATUTORY OR IMPLIED WARRANTY LASTS, SO THE ABOVE LIMITATION MAY NOT APPLY TO YOU. WE ARE NOT RESPONSIBLE FOR DIRECT, SPECIAL, INCIDENTAL OR CONSEQUENTIAL DAMAGES RESULTING FROM ANY BREACH OF WARRANTY OR UNDER ANY OTHER

LEGAL THEORY. IN SOME JURISDICTIONS THE FOREGOING LIMITATION DOES NOT APPLY TO DEATH OR PERSONAL INJURY CLAIMS, OR ANY STATUTORY LIABILITY FOR INTENTIONAL AND GROSS NEGLIGENT ACTS AND/OR OMISSIONS, SO THE ABOVE EXCLUSION OR LIMITATION MAY NOT APPLY TO YOU. SOME JURISDICTIONS DO NOT ALLOW THE EXCLUSION OR LIMITATION OF DIRECT, INCIDENTAL OR CONSEQUENTIAL DAMAGES, SO THE ABOVE EXCLUSION OR LIMITATION MAY NOT APPLY TO YOU.

- WE Will Not Cover Or Be Responsible For The Following:

- Malfunctions caused by unauthorized disassembly and modification of the instrument.

- Failure caused by accidental knock or drop during use and handling.

- Failure caused by lack of reasonable maintenance or environmental requirements.

- Failure caused by incorrect operation according to the instruction manual

- Instrument and accessories damage caused by human reasons.

- Failure caused by self-repair without our company's permission.

- Instrument failure due to unstable local voltage.

- Fault or damage caused by force majeure such as fire, earthquake, etc.

Contact Information

VioUV

Customer Service Phone Number 1-800-641-2957

www.viouv.com